

● SYSTEM :: QUORUM

Appendix A



From *followers*
to standing.

The mandate layer for Russians abroad. Verified mandates, institutional standing — built from existing online services.

VERSION

1.0 — Master Plan

TARGET

Q4 '26

AUDIENCE

Organisers, Lawyers, Donors, NGOs

OUTPUT

eIDAS-Qualified Institutional Standing

QUORUM: FROM FOLLOWERS TO STANDING

Legal-tech utility converting diaspora numbers into verifiable institutional power.

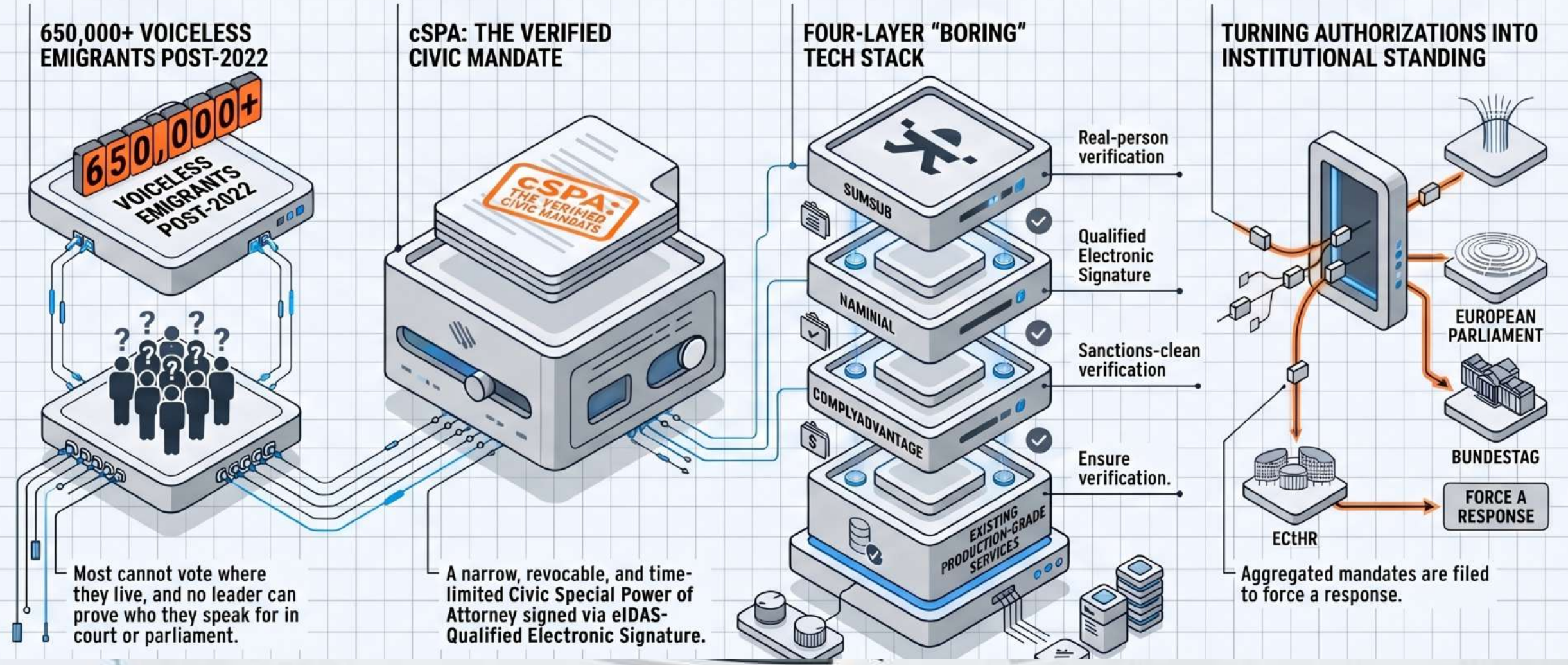

SYSTEM DIAGNOSTIC BOX

The bottleneck is not the absence of leaders. It is the absence of a verifiable mandate.

FAULT 01: No vote at home. Foreign polling stations thinned, identification gated, severe prosecution risks for participation.

FAULT 02: No vote abroad. Local elections gated to citizens. Diaspora pays VAT/rent, but local MPs have zero structural reason to care.

FAULT 03: No verified representation. Current leaders speak from personal stature and Telegram reach. Parliamentary committees cannot lawfully count social media followers.

[650,000+]
Russians left
after 22.02.2022.



INITIATIVE	FORM	STRENGTH	GAP
Better Call Yashin	Personal initiative (\$5 TMG)	[OK] Casework, affidavits	[ERR] No aggregated mandate; cannot bank/hire in project name
AWC Consuls	Unincorporated	[OK] Pro-bono immigration help	[ERR] No legal entity or mandate registry
edinorosam.net	Hackathon platform	[OK] Tech mobilization	[ERR] Not a representation mechanism
PACE Platform 2621/2025	Inter-parliamentary	[OK] First formal CoE seat	[ERR] Needs qualifying civic vehicles to feed it
HK Watch	UK Charity+CLG	[OK] Proven model (BNO visa wins)	[OK] The model to replicate, not a competitor

The gap is a mandate layer that any of these can plug into. Quorum is that layer.

650K+

Russians abroad
post-2022

0

Verified individual
mandates today

eIDAS

Legal effect =
wet signature

Q4 '26

Pilot target:
1,000 mandates

> To unite for the sake of uniting is a mistake.
Coordinate by specific campaigns – yes; unite – no. █

// Leonid Volkov, on diaspora opposition strategy.

OUTPUT GOAL: Within 6 months, show up at PACE, EP, Bundestag, and a UK APPG with verified, sanctions-screened, revocable, individually-signed authorisations.

System Boundaries & Design Refusals

ACTIVE STATES (IT IS)

- [+] A thin civic-mandate utility, plug-in for any existing initiative
- [+] Built entirely from existing, production-grade online services
- [+] Auditable, sanctions-screened, revocable in one click
- [+] Faction-neutral infrastructure (Volkov's spirit)

DISABLED STATES (IT IS NOT)

- [×] A political party (Foreigners cannot lawfully fund parties via PPERA s.54)
- [×] A government-in-exile (Triggers US FARA risk & extremist contagion)
- [×] An electoral proxy (cSPA explicitly excludes voting rights)
- [×] A single leader's brand or faction
- [×] A futurist, unproven liquid-democracy/ZK-biometric demo

Structured Civic Mandate Stack (Exploded View)



Aggregated mandates routed to named institutions.
Function: EU Transparency Register, PACE Platform, ECtHR Rule 44 §3.

Narrow, time-limited, revocable mandate.
Function: eIDAS QES execution – exact same legal effect as a wet signature across 27 EU states.

Passport + ICAO 9303 NFC liveness. Storage EU primary, CH secondary.
Function: Each principal is a real, sanctions-clean person.

UK CLG primary. Paired German e.V. (advocacy + research).
Function: Operations, staff, contracts. No political-purpose bar.

Threat Mitigation: The ZKP Firewall



Step 1: NFC Extraction. Smartphone reads ICAO 9303 MRZ optical password, unlocking NFC chip via BAC/PACE to extract state-signed photo.

Step 2: Liveness Check. ISO 30107-3 PAD Level 2 verifies physical human against extracted chip data.

Step 3: Zero-Knowledge Proof (ZKP) Generation. System verifies citizenship and age locally. Passport never transmits to server.

Step 4: Output to Verifier. Platform outputs a mathematical token: " $\geq N$ distinct, sanctions-screened, non-revoked principals authorise this position."

PERFECT DATA MINIMIZATION: Verifiers (PACE, Bundestag) see certified counts, never names. FSB intercepts yield useless cryptographic hashes, eliminating honeypot risks.

The Stack: Boring. Working. Available Today.

LAYER	FUNCTION	VENDOR	WHY
01	INCORPORATION	Companies House	UK CLG online, ~£12, ~24h
03	KYC + PASSPORT	Sumsub	Cyprus-HQ; admits Russian passports
04	SANCTIONS	ComplyAdvantage	Real-time UK OFSI / EU 269/2014
05	QES (HIGH-STAKES)	Namirial / InfoCert	eIDAS Art. 25(2) compliant
06	AES (ROUTINE)	DocuSign / Yousign	Audit trail, SES/AES tiering
07	CLOUD (PRIMARY)	Hetzner Frankfurt	GDPR Art. 9 special-category processing
10	STORAGE	Tresorit / Proton Drive	Swiss zero-knowledge
11	LOBBY REGISTER	EU Transparency Register	Opens EP committees

The Application Layer: Who Plugs In

Better Call Yashin (Service Desk).

Plugs in to request principal-issued cSPAs to file affidavits and amicus briefs with documented authority, not just personal stature.



edinorosam.net (Developer Pool).

Plugs in to build campaign-specific tools using the mandate registry's verifier endpoint, bypassing the need to reinvent identity auth.



Quorum API /
Registry Hub

Anti-War Committee (Consuls).

Plugs in to back pro-bono extradition and immigration filings with verified-mandate counts.

Diaspora Chapters.

Plugs in to show local city councils a verified count of constituents per ward, converting economic presence into local political weight.

[+] COPY

- **Hong Kong Watch & HKers in Britain:** Specialised charity-form advocacy. Won BNO visas and home fee status. Did not pretend to be a parliament.
- **Tibetan Green Book:** Voluntary sliding-scale tax (\$1.10-\$44). Funds institutions and creates ECOSOC-compliant member legitimacy.
-  **Volkov's Protocol:** Coordinate by campaign – do not unite.

[X] AVOID

- **Belarusian CC 2024 Election:** Single online election design failed (6,723 voters, 3% turnout). Never stake legitimacy on a single terrified diaspora election.
- ✗ **Guaidó Interim-Gov Model:** Recognition without domestic power decays rapidly (dissolved Dec 2022).
- 🚨 **FBK Terrorism Cascade:** 27 Nov 2025 designation equals donor liability contagion. Never frame as a government-in-exile.

Implementation: The Operational Roadmap

No mood-board futures. Specific deliverables.

Block 1: Foundation (Days 1–30)

- Incorporate UK CLG
- EU Transparency Register
- Open Tide/Wise banking
- Pick Sumsub/Namirial stack
- Draft v1 legal pack

Block 2: Pilot (Days 31–90)

- Recruit first 100 principals
- First PACE Platform submission
- UK APPG written evidence
- ECtHR Rule 44 §3 intervention

Block 3: Scale (Days 91–180)

- Open German e.V.
- Scale to 1,000 mandates
- Bundestag Petitionsausschuss filing
- KPI dashboard live

Block 4: Standing (Months 6–12)

- CoE INGOs application
- 5,000 active mandates
- EUDI Wallet integration
- First independent audit

Risk & De-risking (Threat Model)

[CRIT]

FARA Exposure (USA) → Board majority US-resident; LDA registration with §613(h) exemption; DOJ Rule 2 advisory opinion; Never hold out as government-in-exile.

[CRIT]

Sanctions Violation → Hard-block at onboarding via ComplyAdvantage; ≥99% match thresholds; strict reliance on OFAC NGO General License framework (UNSCR 2664).

[CRIT]

UK FIRS Enhanced Tier → Documented firewall; zero funds or operational direction accepted from any foreign power (NSA 2023).

[CRIT]

FSB Infiltration / Family Retaliation → Pseudonymisation default; selective-disclosure ZKP shows counts not names; air-gapped HSM keys; zero transfer to Russia.

[HIGH]

GDPR Art. 9 Breach → Lawful basis stack 9(2)(a)+(d)+(e); mandatory DPIA; UK + EU controller-processor agreements.

TOTAL ENVELOPE: ~£110K – ~£250K

UK CLG inc. + counsel:	£3K–£8K
German e.V. reg:	€4K–€10K
Sumsub KYC / Namirial QES:	~£3K / ~€5K
Two-person ops team (PT):	£60K–£120K

Note: Within reach of a single mid-sized democracy-fund grant or 3-5 founding donors.

The window is two to three years.

The post-2022 wave of Russian emigration has perhaps 24–36 months of continued Western political attention before a frozen conflict or quiet diplomatic settlement reduces its salience. The infrastructure to convert that attention into standing must be built now.

Quorum is small enough to start in **30 days**. The first parliamentary committee to accept its cSPA evidence sets the precedent for everyone who follows. **Execute.**

THE META-GUILD BLUEPRINT

Engineering the Neo-Artisan
Network State.

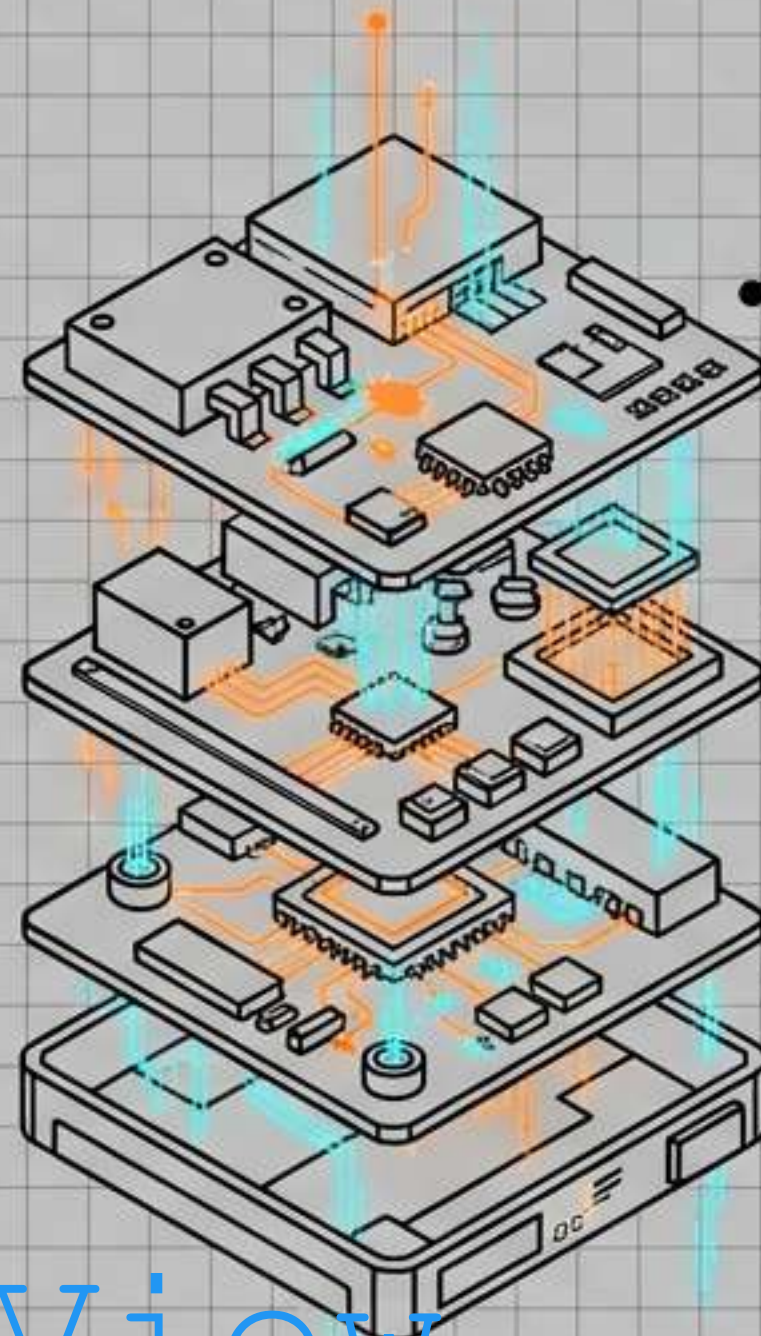

LAYER_01:
SOCIOLOGICAL_DIAGNOSTIC

LAYER_02:
LEGAL_INFRASTRUCTURE_cSPA

LAYER_03:
TRI-CAMERAL_GOVERNANCE

Appendix B

Quorum ::

Futuristic View

SYS_VER: 1.0.0
STATUS: INITIALIZED
AUTHOR: METASTATE



SYSTEM DIAGNOSTIC: LIQUID MODERNITY

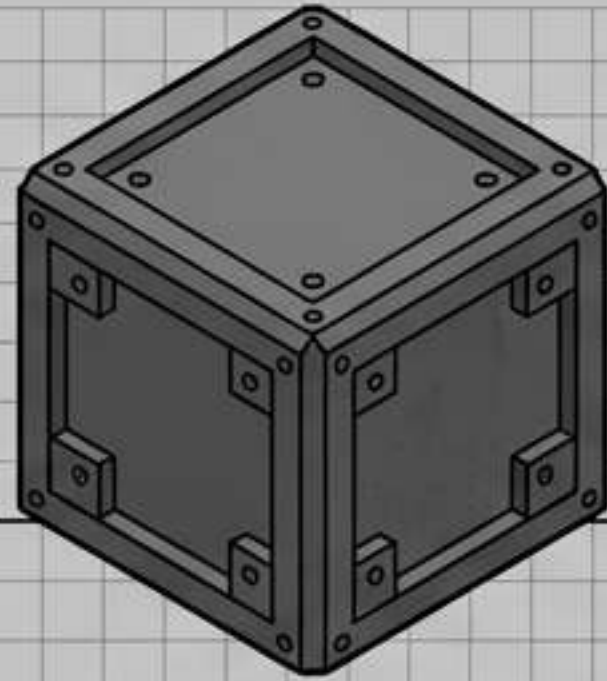

- STATE: Solid / Rigid
- STRUCTURE: Fixed Institutions, Long-term commitments, Factory labor.
- WORKER_STATUS: Proletariat (Selling labor power).

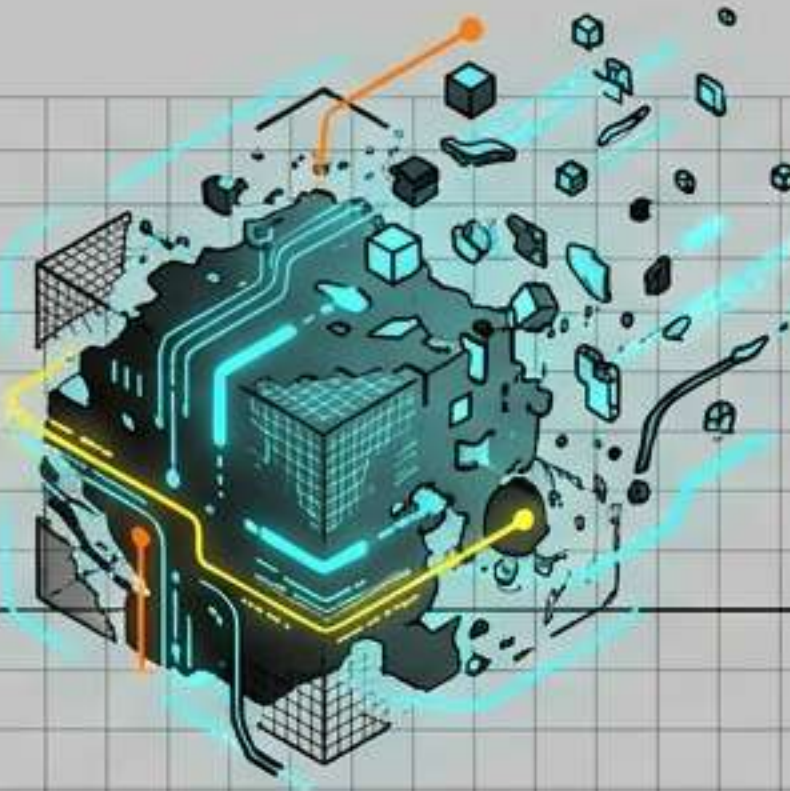

- STATE: Fluid / Dissolving
- STRUCTURE: Algorithmic automation, Gig platforms, Temporary identities.
- THREAT_VECTOR: The Useless Class (Harari) - Labor decoupling from economic utility.

WARNING: FLUID INSTITUTIONS CAUSE LACK OF STANDING. URGENT PATCH REQUIRED.

THE ANTIDOTE: NEO-ARTISAN HARDWARE

BRAIN/COGNITIVE UNIT

SENSORY ARRAY/VISION

ACTUATORS/HANDS

CHASSIS/BASE

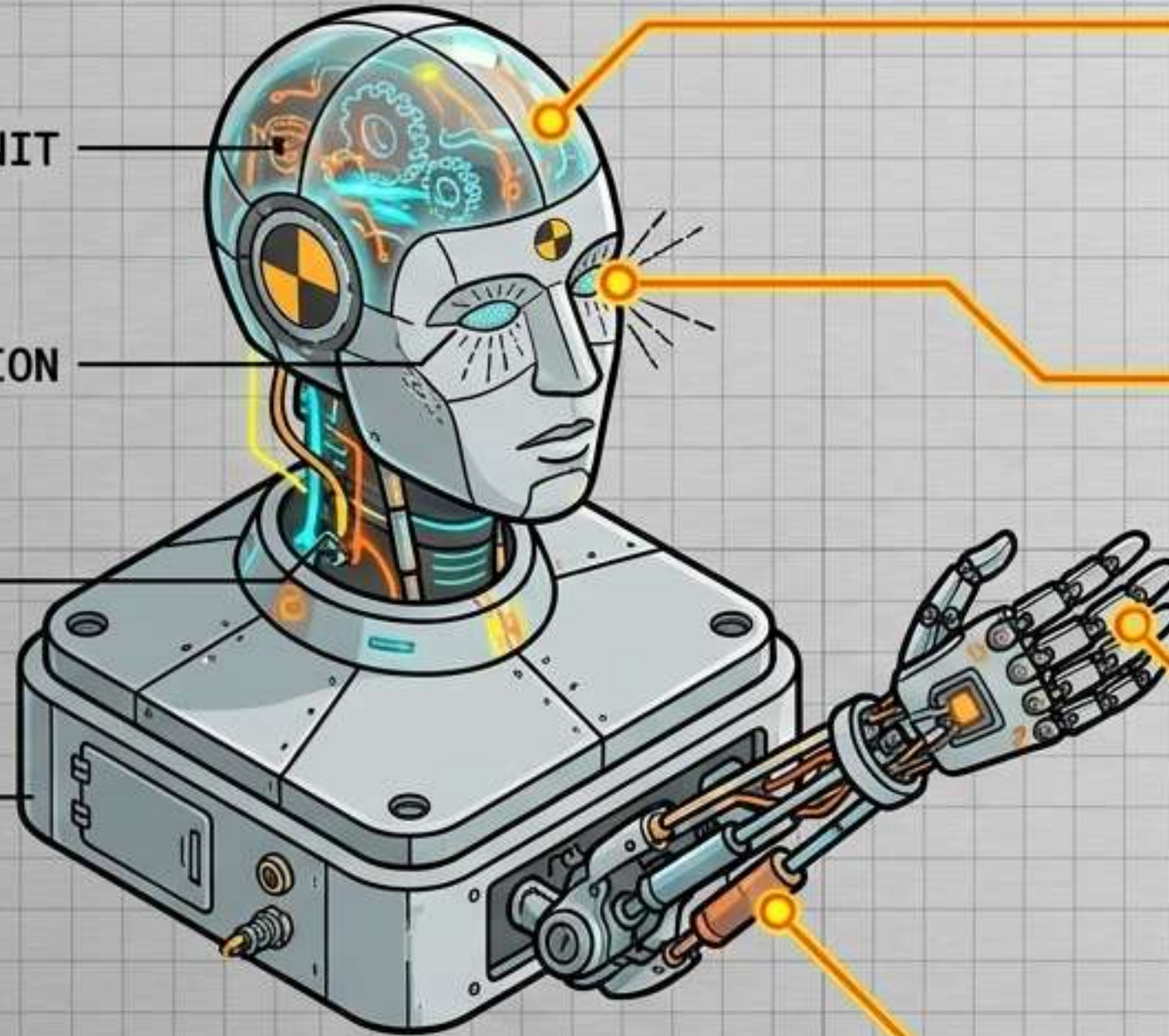

[Cognitive Core]
Ambiguity Navigation:
Unpredictable problem-solving;
crisis response.

[Sensory Array]
Extreme Empathy: High-touch
human interaction (healthcare,
mentorship).

[Actuators]
Embodied Craft: Unautomatable
physical nuance and extreme
craftsmanship.

[Chassis]
Ownership of Means: Complete
control over tools, APIs, and
workshop output.

CLASS_IDENTIFIER: Proprietary Petty Bourgeoisie / Maker Class.
STATUS: Resistant to algorithmic replacement.
FUNCTION: Keepers of the subtle touch and ethical judgment.

COMPONENT COMPARISON: LABOR MODELS

	Wage Laborer (Proletariat)	Historical Guild	Meta-Guild (Neo-Artisan)
OWNERSHIP:	None (Sells labor)	Master owns workshop	Sovereign Digital/ Physical Tools
AUTONOMY:	Dependency (Employer rules)	Local cartel control	Decentralized & Global
MOTIVE:	Fixed Wage	Profit from goods	Ethical Craft + Shared Equity
HIERARCHY:	Flat (Limited mobility)	Apprentice > Journeyman > Master	Meritocratic Peer Review
NETWORK:	Labor Union (Rights focus)	Local Civic Lobby	Transnational Network State

EXPANSION CARTRIDGES: THE 8 META-GUILDS

SLOT_01: NANO-FORGERS
Forging carbon nanotubes
& self-healing polymers.

SLOT_02: GENE ALCHEMISTS
Ethical CRISPR design
& synthetic biofuels.

SLOT_03: REALITY WEAVERS
Immersive AR/VR spatial
environments.

SLOT_04: TEMPORAL ARTISANS
Quantum time-dilation
management in R&D.

SLOT_05: DATA DIVINERS
AI interpretability &
ethical oversight.

SLOT_06: TERRAFORMERS
Biosphere construction
for off-world habitats.

**SLOT_07: CONSCIOUSNESS
CURATORS**
BCI interfaces &
neuro-aesthetic therapy.

SLOT_08: CRYPTO-SMITHS
Decentralized governance
& zero-knowledge identity.

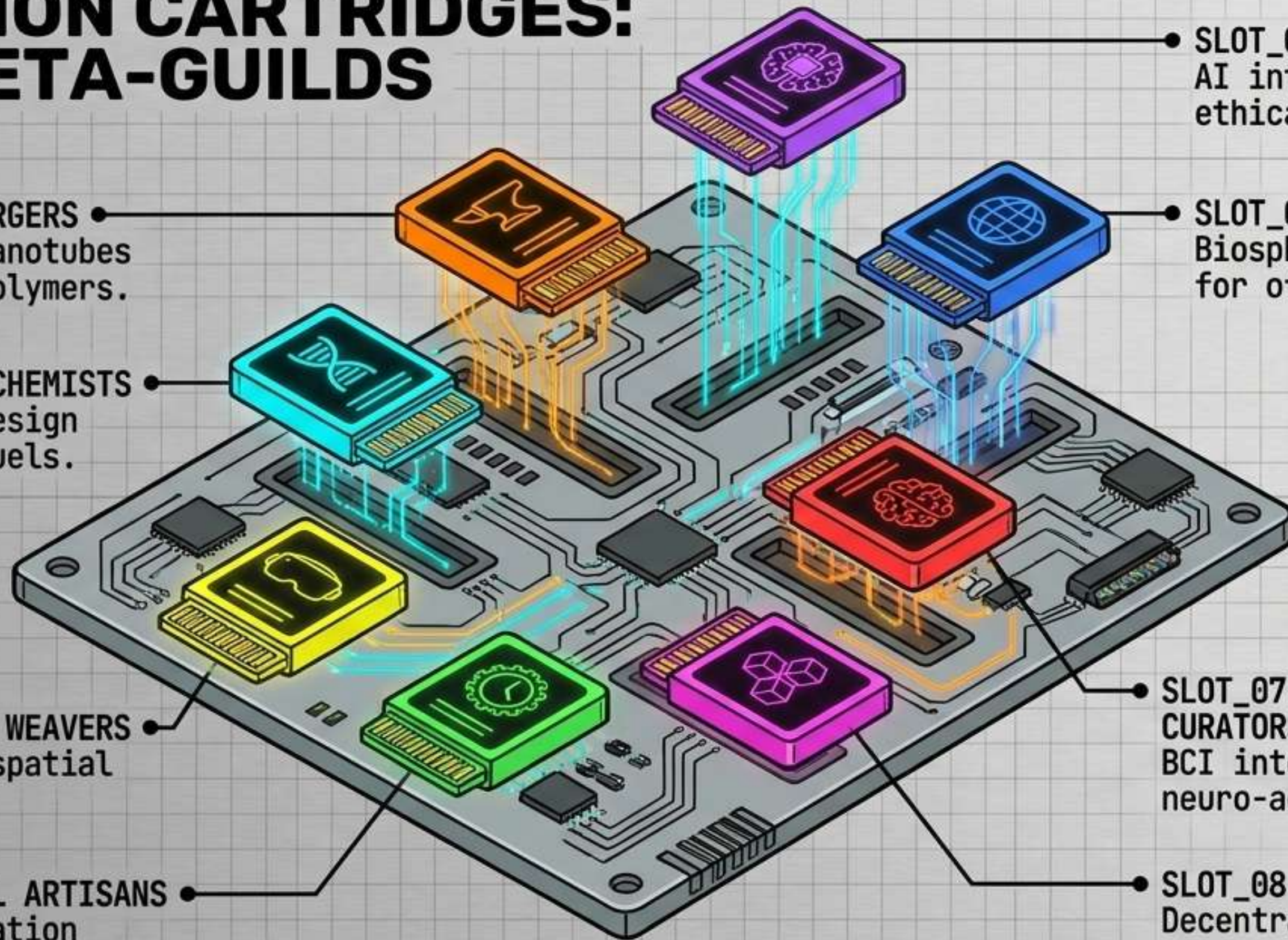

THE MISSING LAYER: INSTITUTIONAL STANDING

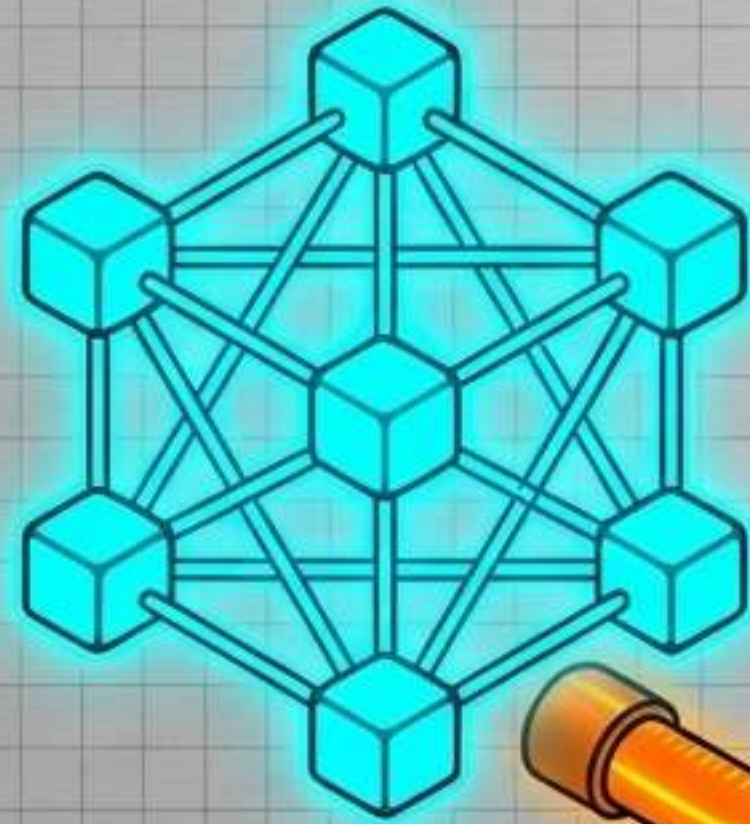

Social Media Followers
Emigrants



Broken Circuit



European Parliament / PACE
Institutional Standing

ERROR 403: LACK OF LEGAL STANDING.

ROOT_CAUSE: YouTube views and Twitter followers are not legally auditable mandates.

VULNERABILITY: Founders rely on non-transferable personal stature (e.g., Yashin, Navalny Foundation).

RESULT: Inability to intervene in ECtHR cases, submit formal petitions to the Bundestag, or claim PACE representation.

THE PATCH: CIVIC SPECIAL POWER OF ATTORNEY (cSPA)

Definition: A narrowly-scoped notarial delegation pipeline transforming "I support" into "I have legally authorized you to represent me."

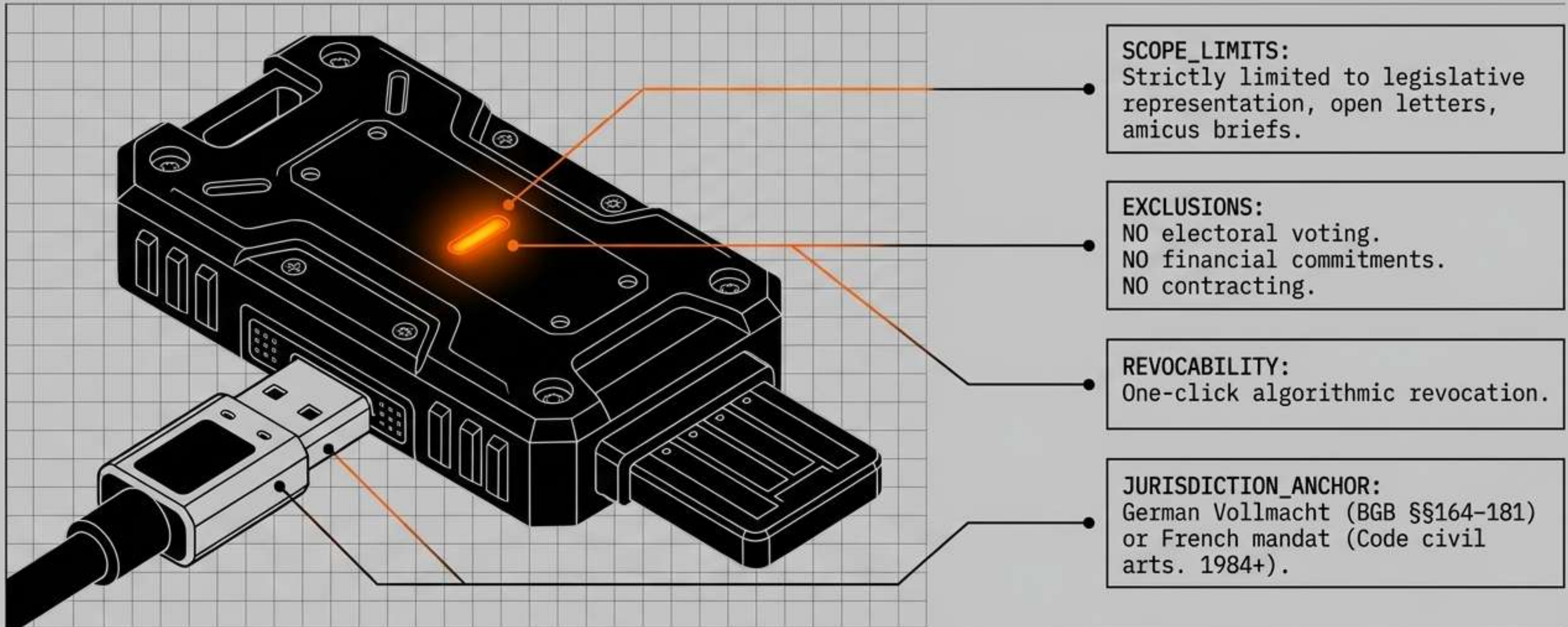

THE E-MANDATE PIPELINE



Station 01: Biometric Intake

ACTION: NFC Passport Scan (ICAO 9303).
VERIFICATION: MRZ read + PACE protocol + Liveness detection selfie.

Station 02: Cryptographic Signature

ACTION: eIDAS Qualified Electronic Signature (QES).
LEGAL_WEIGHT: Same legal effect as a handwritten signature across all 27 EU Member States.

Station 03: Tokenization

ACTION: cSPA Token Minting via walt.id or Sphereon EUDI wallet.

Station 04: Institutional Aggregation

ACTION: Output as fully verifiable, legally binding diaspora mandate.

PRIVACY SHIELD: ZERO-KNOWLEDGE PROOFS (ZKP)

Problem Statement: Hostile states execute transnational repression; EU transparency registers demand verified humanness.

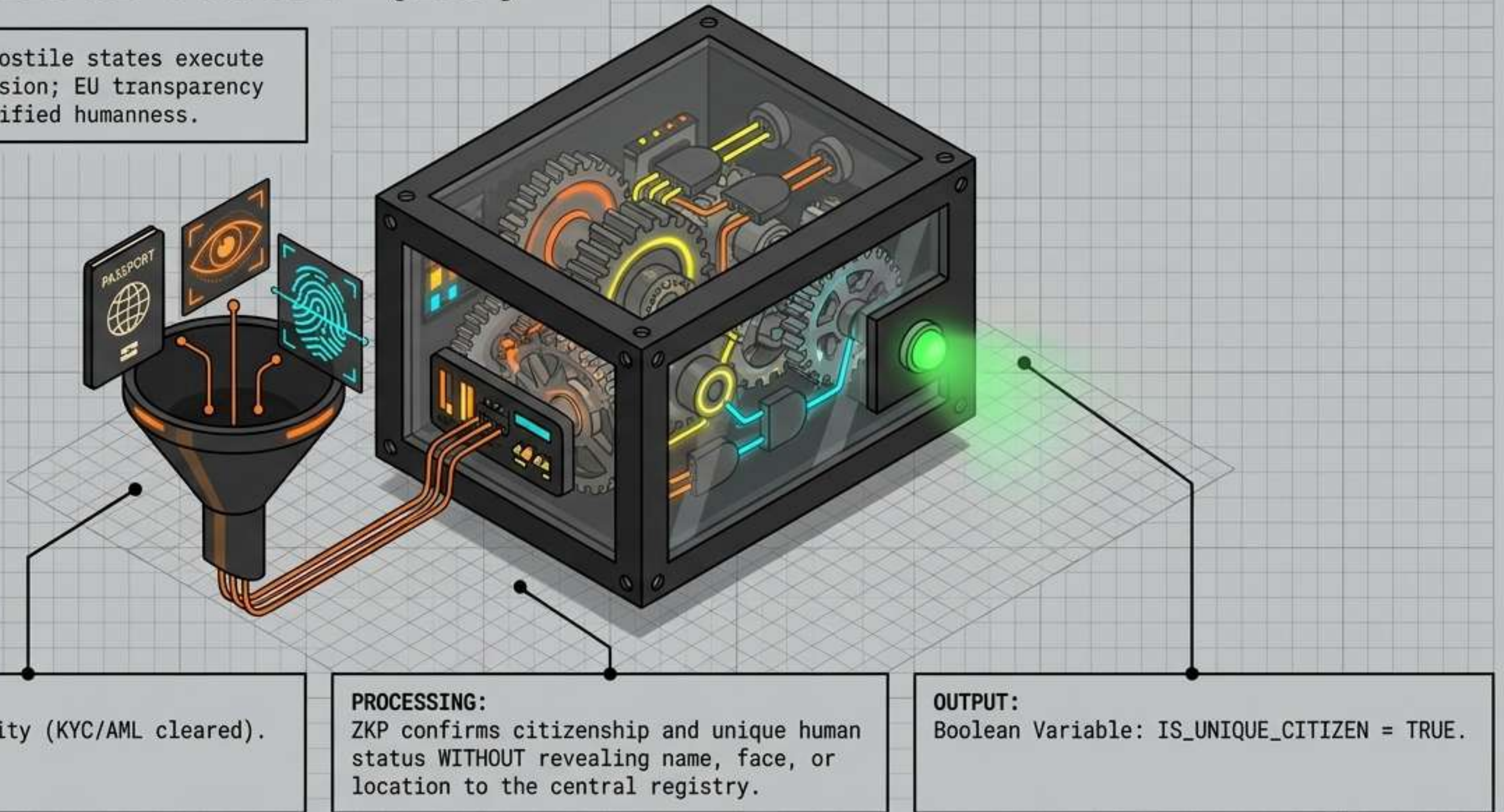

Impact: Absolute privacy guarantees against state intelligence agencies while delivering mathematically proven voter rolls to Western parliaments.

STRUCTURAL ARCHITECTURE: METASTATE FEDERATION

Server 2: Germany (EU Bridge)
ENTITY: non-gemeinnütziger e.V. + gemeinnütziger e.V. (Solidaris Splitting).
FUNCTION: EU-facing political advocacy and research. Direct pipeline to the Bundestag and EU Parliament.

Server 1: United Kingdom (Central Router)
ENTITY: Company Limited by Guarantee (CLG).
FUNCTION: Main operations, public campaigns, mandate registry host. Unrestricted by political-purpose bars.

Server 3: United States (Policy Arm)
ENTITY: 501(c)(4) + 501(c)(3).
FUNCTION: Unlimited issue lobbying. Firewalled from foreign election expenditure to satisfy FARA.

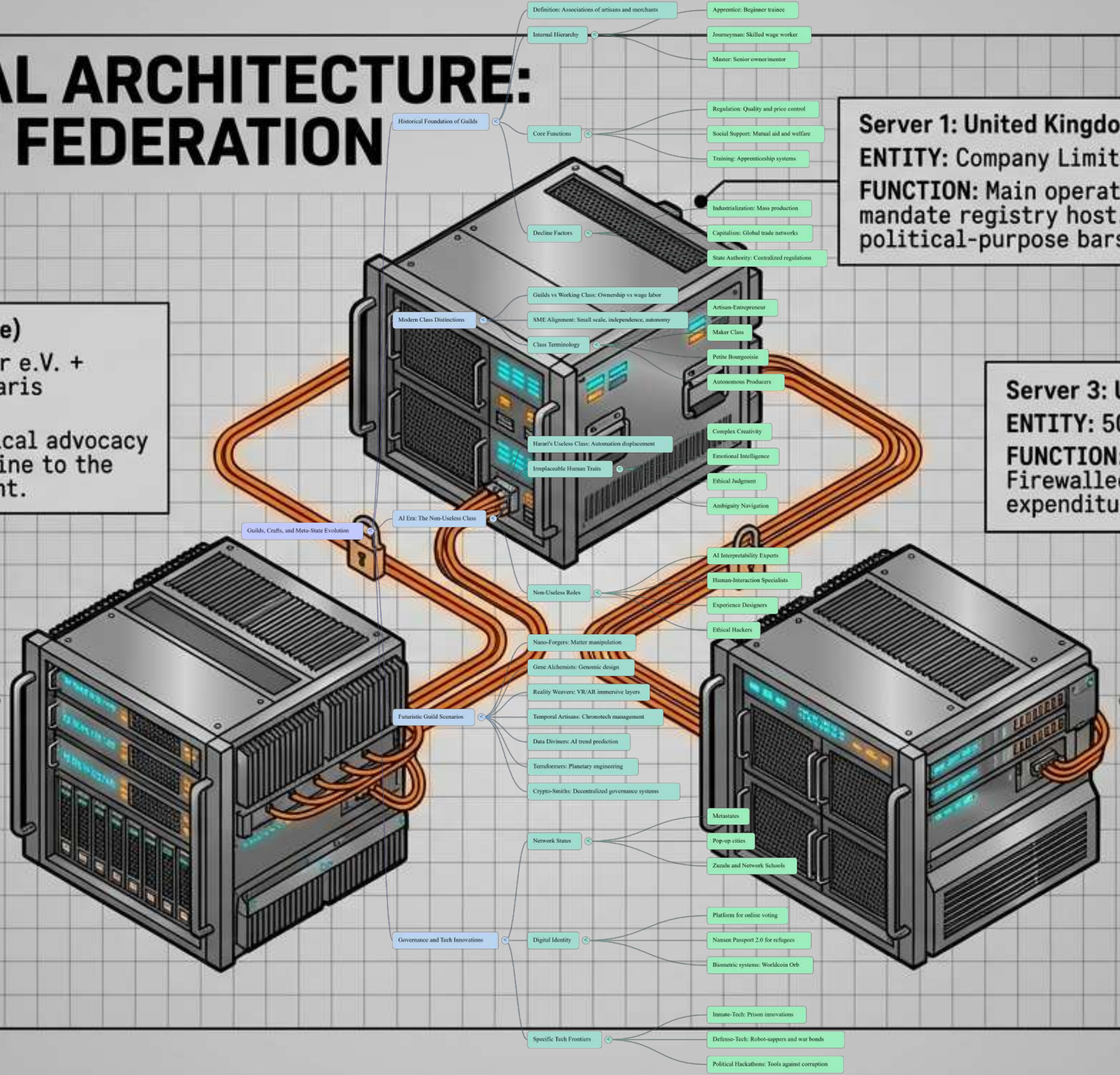

GOVERNANCE: TRI-CAMERAL MOTHERBOARD

Processor 01: Delegate Council

METHOD: Elected online via open civil-society lists.
SIZE: 60-80 seats.

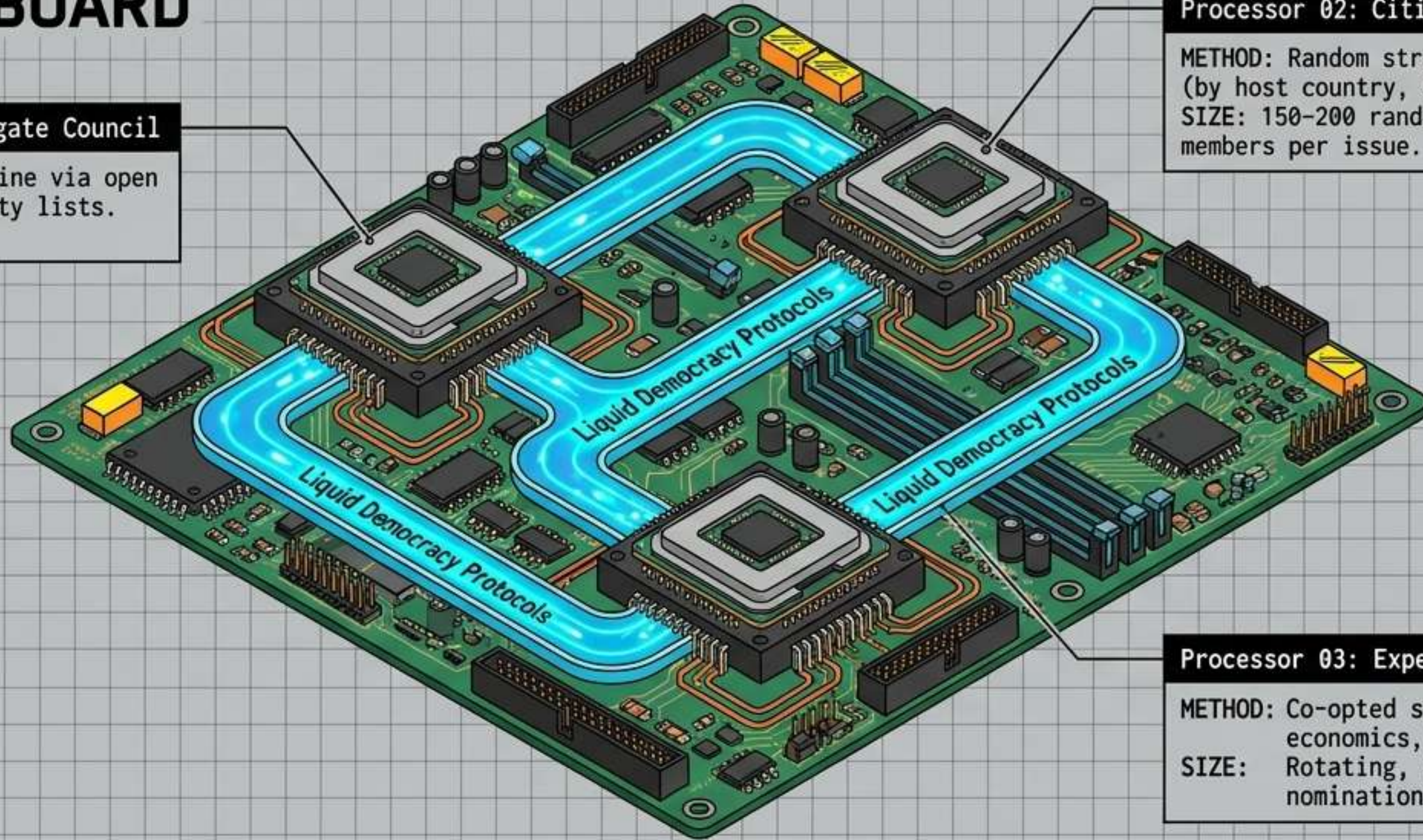

Processor 02: Citizens' Assembly

METHOD: Random stratified sortition (by host country, age, profession).
SIZE: 150-200 randomly selected members per issue.

Processor 03: Expert Council

METHOD: Co-opted specialists in law, economics, and security.
SIZE: Rotating, term-limited nominations.

Data Bus Protocol: Fluid delegation layer allows members to proxy votes topically with full audit logs.

DIGITAL GOVERNANCE: LIQUIDFEEDBACK SOFTWARE

Dial Position 1: Admission

FUNCTION: Measuring initial interest and establishing a support quorum.

Dial Position 2: Discussion

FUNCTION: Iterative modification, weighing arguments, drafting alternatives.

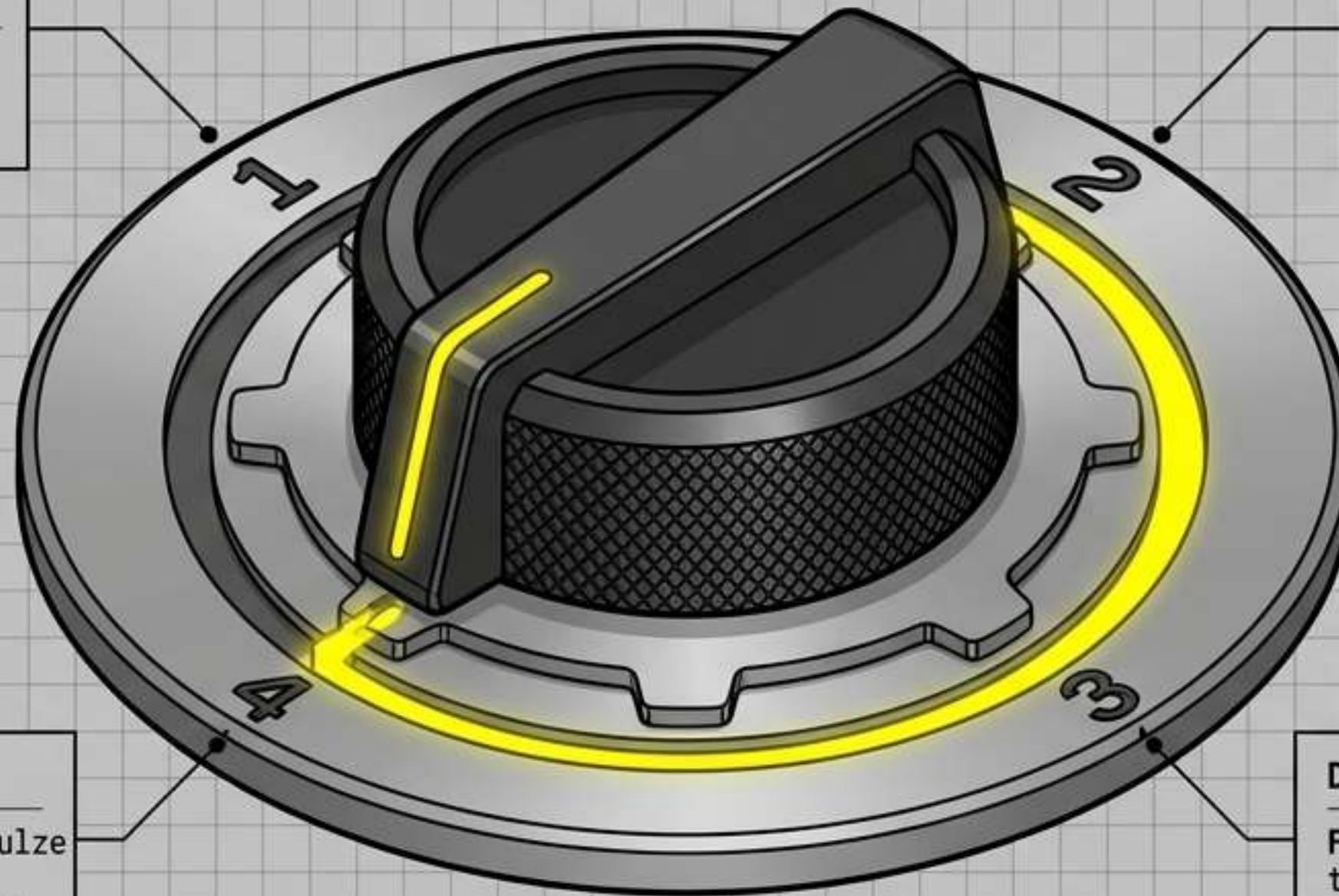

Dial Position 4: Voting

FUNCTION: Execution via the Schulze method (preferential voting algorithm) to eliminate tactical voting and vote-splitting.

Dial Position 3: Verification

FUNCTION: Freezing the resolution text. Protection against political hacking or last-minute malicious edits.

DEPLOYMENT PROTOCOL: DIASPORA INTEGRATION

The Target: PACE Resolution
2621/2025 (Platform for
Russian Democratic
Forces).

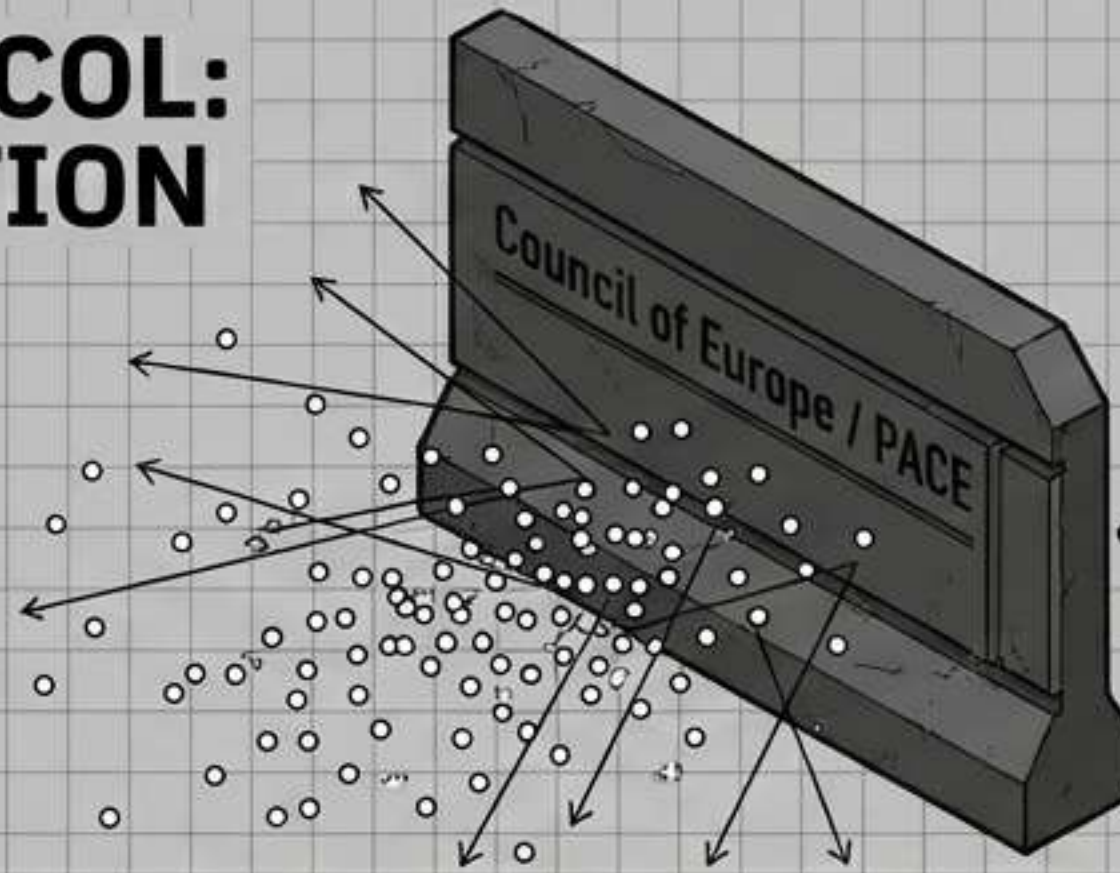

The Error: Current diaspora
relies on unverified YouTube
audiences—3% turnout. Easily
ignored.

BEFORE

AFTER



The Override:

Deploying the cSPA
pipeline to output a
mathematically verifiable,
sanctions-screened mandate
block of 100,000+ emigrants.
The laser beam of
institutional standing.

SYNTHESIS: THE METASTATE STACK

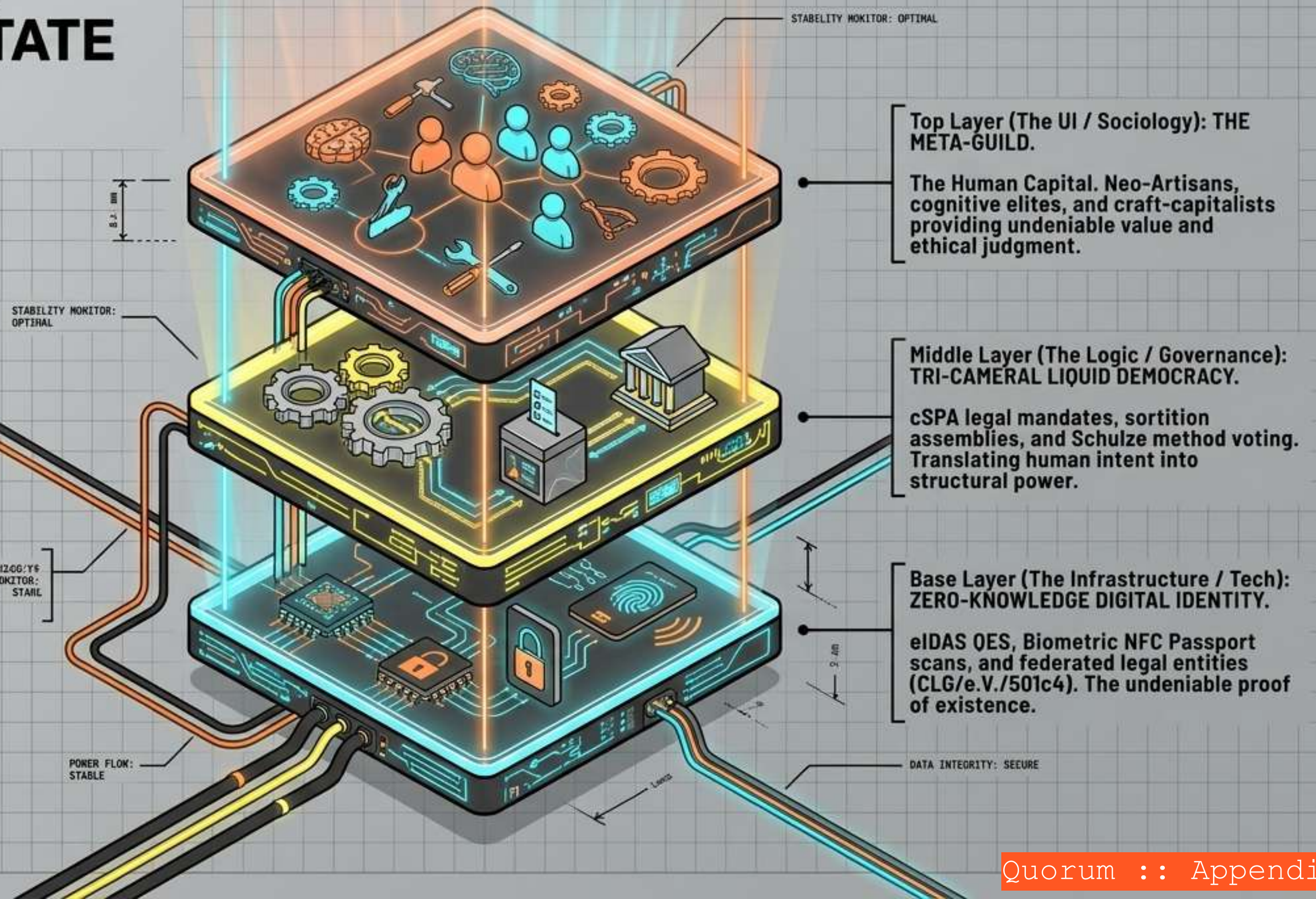

THE META-GUILD MANIFESTO: Rise of the Neo-Artisans

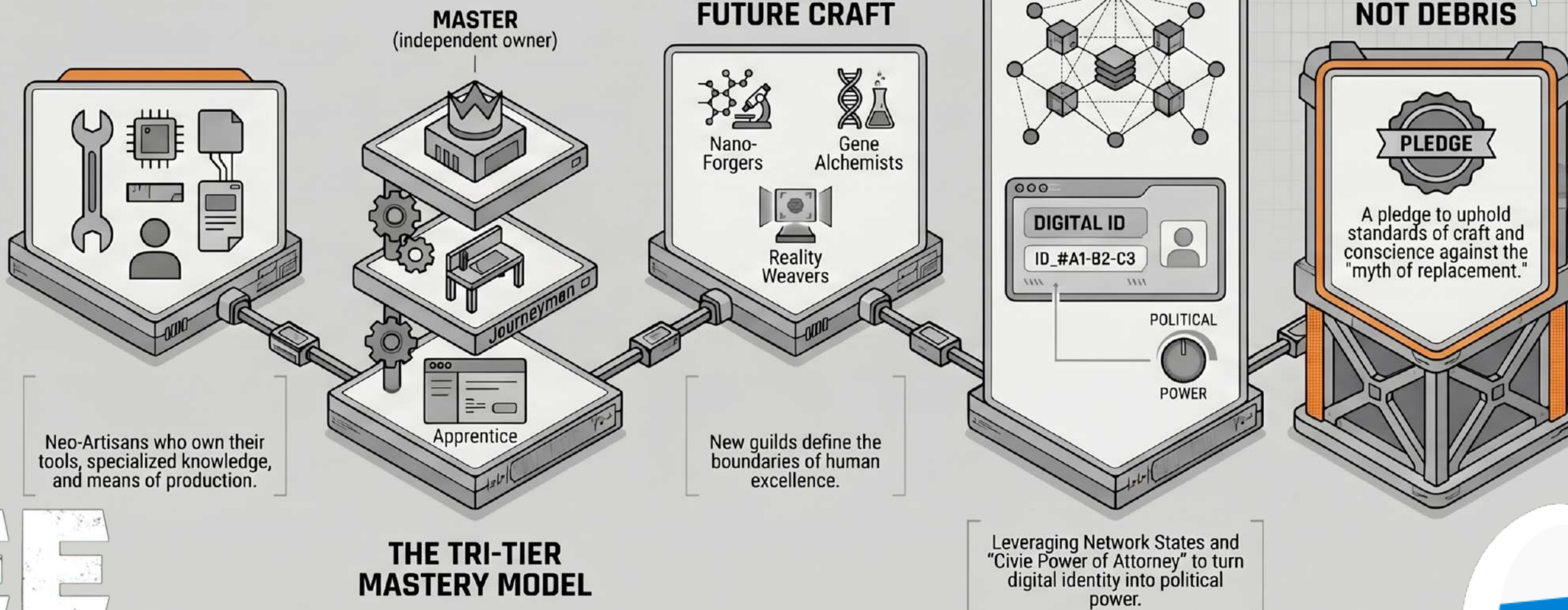

FREE



RUSSIA

01 / We are not the void between the lines of history. We are not debris.

02 / We refuse the tyranny of 'usefulness' measured in spreadsheets and automated outputs.

03 / We claim our dignity through mastery of what only humans can do: bridging divides, crafting beauty, and guiding with empathy.

04 / Technology is our chassis; the human spirit is our core.

> SYSTEM_READY. AWAITING_HUMAN_INPUT _